



**The First Presbyterian Church
of Washingtonville**
The Good News-Letter



October 2014



Aikido Demonstrations

Taco Soup (served
and for sale)



Boy Scout Monkey Bridge

Fall Community Fair
Saturday, October 18
10:00 AM - 3:00 PM



crafts

White Elephant Sale



Candy Sale

**First Presbyterian Church
of Washingtonville**

Session Moderator
Rev. Bill Doster
201-394-7017

Clerk of Session
Deborah Chedister

The Session

LouAnne Blanchard 2014
Tim Erchick 2014
Bobbie Trager 2014*
Nancy Bruscano 2015
Lois Dunikowski 2015
Doris Dunn 2016
Nancy Popoloski 2016

Board of Deacons

Jorus Beasley 2014*
Mark Chedister 2014
Beth Tyrrell 2014
Carrie Maurya 2015
Debbie Woodmansee 2015
Peggy Wright 2015
Tanya Bray 2016
Beth Cooke 2016

*indicates second term

Office Manager
Cynthia Carey

30 Goshen Avenue
Washingtonville NY
845-496-3814
firstpres@frontiernet.net

Office Hours are:
Tuesday - Thursday
9:00 am - 3:00 pm

First Presbyterian Church
www.fpcw.makeswebsites.com

Presbytery of Hudson River
www.hudrivpres.org

Food for Thought

Discipleship is a sober, difficult, and confusing calling to me. As we read through the Gospel of Matthew, I see the disciples struggle with the teachings and actions of Jesus. Matthew's congregation was living out those struggles fifty or sixty years after those who had walked with Jesus. He had said, "Take up your cross and follow me." Matthew's congregation had itself seen those who followed him crucified. The Jewish Temple had been destroyed. In Matthew, the tension between the Jewish leaders and Jesus was drawn clearly. Two Jewish sects survived the fall of Jerusalem—The Jamnian Pharisees and those who followed Jesus.

Peter was asked by Jesus, "But who do you say that I am?" Matthew places this conversation in the district of Caesarea Philippi, where Vespasian and Titus relaxed and enjoyed their conquest in sight of a newly constructed Roman temple. If Jesus is *The Messiah*, the anointed one, or *The Christ* in Greek, He bids us confess him, not Caesar, Lord.

In most of the world, understanding what following Jesus entails is, as I wrote at the beginning of this string, "sober, difficult, and confusing." How do you love your enemies in the Middle East? Or in the chaos of emerging powers in Africa? Or in the turmoil of South America? How do we hold out a helping, liberating hand for the marginalized and oppressed in New York State?

Love in the trenches,

Pastor Bill

**IN CASE OF
PASTORAL
EMERGENCY**

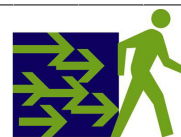

Important News: Pastoral Emergency Care

If emergency care is needed, please contact Pastor Bill Doster at w.b.doster@verizon.net or call him at 201-501-8951.

A church officer checks the answering machine in the office daily when Cynthia is not scheduled to be in the office.

Worship

We have a new member of the Chancel Choir, and we are delighted to welcome Dolores Taylor to our choir family. Dolores, we are so excited that you have decided to join us. If you, too, might be yearning to sing with us and share God's gift of music, please feel free to speak with Nancy Popoloski.

Rosemarie Zlotnick has shared her talents on the organ and piano again on a couple of recent Sundays. Thank you, Rosemarie, for your support of our music program and accompaniment of the choir's anthems. We always look forward to having you with us.

Bill Hooper has become a regular in providing his special organ, piano and vocal talents to our FPCW worship services. Bill will be at FPCW the month of October. We love you, Bill, and look forward to each Sunday you are with us.

Nancy Popoloski continues to lead our Chancel Choir and to find the right choices of music to fit with the message of the day. Thank you, Nancy, for all you do.



WORLD COMMUNION Sunday this year is October 5th. We hope you will be in church to join the Christian world in sharing this holy sacrament together.



The deadline for the monthly newsletter is the 20th of each month. Please submit the news you want to share, to Cynthia on or before the **20th** of each month at firstpres@frontiernet.net.

A note from Rev. Ruth Wainwright regarding the FPCW folks who attended the celebration at the Bethany PC on August 31:

- It was great to see all of you!!! I'm sure others will thank you for attending Ed and Shirley's celebration, but it was a special treat for me. I only wish I could have visited with you more. Another time.

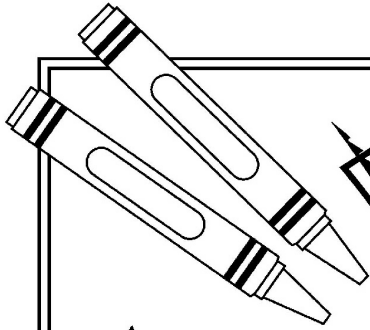





PUZZLE



A promise to the earth



After the flood in Genesis, God promised to “never again ... destroy all living creatures” (Genesis 8:21, NIV).

Directions: Using the picture clues below, write each small word in the blanks to complete God's promise in Genesis 8:22, NIV.



“As long as the  _ _ _ th

 _ _ _ ures,  _ _ _  _ _ _

and har _ _ _ , c _ _ _ 

and h _ _ _ , $1+2=$  _ _ _ mer

and  _ _ _ ter, day and night

w _ _ _  n _ _ _ r  cease.”

GENESIS 8:22, NIV

Answer: As long as the earth endures, seedtime and harvest, cold and heat, summer and winter, day and night will never cease.” Genesis 8:22, NIV

Equals at Communion

After saving England from Napoleon's threats in 1815, the Duke of Wellington achieved hero status. One Sunday as the duke approached the altar for communion, a poor man from London's streets, wearing rags, knelt beside him. The indignant minister whispered for the vagrant to move away. "Don't you realize this is the great Duke of Wellington?" he asked.

When the duke overhead, he responded, "Leave him alone. We're all the same here. The ground is level at the cross."

That's the spirit in which we celebrate World Communion Sunday on the first Sunday of October. Paul says believers share the Lord's Supper by partaking of the "one bread" (1 Corinthians 10:17). Everyone at the communion table is equal in God's sight, needing his forgiveness and grace.

The Progression

Get to know Jesus well because the more you know him, the more you'll love him. And the more you love him, the more you'll want to follow him. And the more you follow him, the more you'll become like him. And the more you become like him, the more you become yourself. —Ned Erickson

The Feste Burg

"A Mighty Fortress," the hymn written by Protestant reformer Martin Luther in 1529, is powerful in English but even better in its original German. Historian Michael Streich notes that Luther compares God not only to a fortress but to a completely secure stronghold, or *Feste Burg*.

"A burg was a fortified town," Streich says. "When invaders approached, the surrounding populace fled to the safety of the walls" – sometimes to layers of walls within walls. Luther's hymn compares God to the most powerful of all burgs, with eternally unbreakable walls.

When we need a place of refuge, God offers his Mighty Fortress, his *Feste Burg*. Within this refuge, with our value based on our relationship to God rather than on earthly achievements, we'll never be put to shame. Inside this fortified town, the God who desires an eternal relationship with us delivers, rescues and saves us.

—Homiletics

S	M	T	W	T	F	S
O	C	T	1 9:30 AM Bible Study 6:30 G.S. #405 7:00 G.S. #493 7:00 PM Prayer & Bible Study 8:00 PM A.A.	2	3 5:00 PM G.S. #543	4
5 8:45 AM Choir 10:00 Am Worship, Lord's Supper World Communion 8:00 PM A.A.	6 7PM Troop 416 Leadership Meeting	7 7:00 PM Troop 416	8 9:30 AM Bible Study 7:00 PM Prayer & Bible Study 8:00 PM A.A.	9 7:00 Venture Crew 7:00 PM N.A.	10 5:00 PM G.S. #543	11
12 8:45 AM Choir 10:00 Am Worship 8:00 PM A.A.	13 Columbus Day	14 7:00 PM Troop 416	15 9:30 AM Bible Study 7:00 PM Prayer & Bible Study 8:00 PM A.A.	16 4:00-5:30 G.S. #503 7:00 Venture Crew 7:00 PM N.A.	17 3:30 PM G.S. #493 5:00 PM G.S. #543	18 10:00 AM - 3:00 PM Fall Community Fair
19 8:45 AM Choir 10:00 Am Worship 1-5PM Scouts#600/4 8:00 PM A.A.	20	21 7:00 PM Troop 416	22 9:30 AM Bible Study 7:00 PM Prayer & Bible Study 8:00 PM A.A.	23 7:00 Venture Crew 7:00 PM N.A.	24 5:00 PM G.S. #543	25
26 8:45 AM Choir 10:00 Am Worship Reformation Sunday 8:00 PM A.A.	27 7PM Troop 416 Board of Review	28 7:00 PM Troop 416 7PM Troop 416 Committees Meet	29 9:30 AM Bible Study 7:00 PM Prayer & Bible Study 8:00 PM A.A.	30 7:00 Venture Crew 7:00 PM N.A.	31 SIS Fall Retreat at Camp Holmes Reformation Day 5:00 PM G.S. #543	

Sundays - 10:00 am Worship Service
11:00 am Coffee Hour

Church Office Hours are:
Tuesday - Thursday, 9:00 am - 3:00 pm



HAPPY BIRTHDAY TO

2	Lorraine Pasquarelli	12	Lynn Imperato
3	Emily Bulger	18	Mark Chedister
	Jack Bulger	23	Wayne Thode
	Derrek Cooke	27	Kathryn Nishimoto
5	Kieran Bray-Jones	30	Nicholas Imperato

The Fruit of the Spirit

How does the Spirit of God manifest itself through us? Often we think that to witness means to speak up in defense of God. This idea can make us very self-conscious. We wonder where and how we can make God the topic of our conversations and how to convince our families, friends, neighbors, and colleagues of God's presence in their lives. But this explicit missionary endeavor often comes from an insecure heart and, therefore, easily creates divisions.

The way God's Spirit manifests itself most convincingly is through its fruit: "love, joy, peace, patience, kindness, goodness, trustfulness, gentleness and self-control" (Galatians 5:22). These fruit speak for themselves. It is, therefore, always better to raise the question "How can I grow in the Spirit?" than the question "How can I make *others* believe in the Spirit?"

Bread for the Journey: A Daybook of Wisdom and Faith
by Henri Nouwen

With blessings from the Nurture Ministry

Board of Deacons

Food Pantry - The food pantry welcomes all donations. Needed for October will be: soup (dry or canned), can tuna, can chicken, and pudding/Jell-O. Please add at least one of these items to your shopping list. Donations can be placed in the wicker basket outside Hazekamp Hall.

Coffee Hour Needs - All kinds of cookies are welcome. Thank you all for helping the Deacons keep the kitchen stocked!

Prayer Shawl - The Deacons are so happy to have this special ministry to help with their shepherding.

E Prayer Circle - Please contact Lois Dunikowski at lbd9999@hrc.rr.com if you have any prayer requests.

Emergency Use of the Church Building - If any person in our church family is without power, water, or heat, and needs to use the church as a safe haven, please contact your deacon shepherd so he or she can direct your need to the appropriate ministry elder(s).

The Deacons are very happy to serve the members of this congregation. Please let your deacon shepherd know if he or she can help you in any way. (There is a list posted on the bulletin board in the Denniston Room if you are not sure who your deacon shepherd is.)



Calendar of Prayer for our Congregations and Leadership

The endorsed calendar of prayer is a way for us to be united. It's an awesome responsibility and gift to pray for one another. To make our offering on behalf of one another. Each member congregation, staff member, elected servant leader, ministry team, and mission commitment of our Presbytery is represented:

Graham's PC-Pine Bush, New Rochelle PC, First Church Congers, Harrison PC, South PC-Yonkers, and Elder Linda Valentine-Executive Director General Assembly Mission Council.



VISION STATEMENT

*Together, we worship God through our
Study, Stewardship, Service, and Song.*

Call Cynthia at **496-3814** or send an e-mail to firstpres@frontiernet.net
to share your news with our church family!



***First Presbyterian Church
30 Goshen Avenue
Washingtonville NY 10992***

Address Correction Requested